

LATERAL-ACCELERATION EXPERIENCE OF MULTITRAILER VEHICLES IN SERVICE

C. B. Winkler and S.E. Bogard
University of Michigan Transportation Research Institute

ABSTRACT

This paper examines the lateral-acceleration experience of double- and triple-trailer vehicles in regular commercial service. The test fleet included seventeen tractors, eighty-six semitrailers, twenty-eight C-dollies, and sixteen A-dollies spread among five commercial trucking fleets. Data were gathered during 350,000 miles of travel over a period of eight months. Lateral acceleration signals were processed in the frequency domain to compare the rearward amplification qualities of A-trains and C-trains. Results from this normal operating environment agree remarkably well with measurements made previously in severe maneuvers conducted at the test track or in vehicle simulations. Histograms of lateral acceleration experience are also presented. A rearward-amplification-like measure obtained in the time domain corroborates the findings in the frequency domain. Time-domain data also suggest that drivers take note of the lateral performance qualities of their vehicles and modify their driving behavior accordingly.

INTRODUCTION

This paper reports on one element of an in-service field study of long combination vehicles (LCVs) that was conducted by the University of Michigan Transportation Research Institute (UMTRI) for the National Highway Traffic Safety Administration (NHTSA) of the US DOT [1].¹ The objective of this field study, as stated by the NHTSA, was to “evaluate the stability-enhancing characteristics, practicality/reliability, maintenance costs and (fleet) personnel reactions to ABS [antilock braking systems]... and double-drawbar dollies.” Findings regarding the lateral-acceleration performance of LCVs, particularly in relation to the use of C-dollies, are presented herein. Findings on ABS performance and on the operational and economic issues surrounding both ABS and C-dollies can be found in other publications [1,2,3,4].

The authors believe that the findings set forth in this paper are meaningful and that they are fair representations of the lateral acceleration experience of LCVs in the environment of the participating commercial fleets. At the same time, however, it is important to indicate clearly that it is not possible to assign any measure of statistical certainty to the findings to be presented. The effort and funds expended to conduct this study were substantial. Even so, the study was too small—in number of fleets, number of units, and duration in time or in miles—to yield results that could be claimed to be representative in a widespread sense. All observations were made in the northwestern US and are influenced by the geography, weather, and road usage laws of that region. Moreover, each participate fleet has its own distinguishing characteristics of management style, products transported, etc. Finally, the study itself unavoidably caused changes to the standard operating procedures of the participating fleets.

OVERVIEW OF THE FIELD STUDY

Test operations of the LCV field study were conducted in the five contiguous states of Washington, Oregon, Idaho, Nevada, and Utah, which each allow the use of Rocky Mountain doubles on a designated highway system. Four of these five, excluding Washington, allow operation of triples on a somewhat more restricted network. Western doubles may operated in all states. The various types of vehicles in the field study appear in [figure 1](#).

The test fleet consisted of seventeen “vehicles” where a vehicle is the collection of tractors, dollies, and semitrailers that service a single route within a fleet’s operation. While only one tractor is required for this, extra trailers and dollies are generally needed. For example, a triple would typically service three stores and use nine trailers. At any particular time, three trailers would be at a distribution center being loaded with goods, three would be en route to the stores, and three would be at the stores being unloaded and perhaps loaded with return goods. Through variations of such scenarios, the test fleet included seventeen tractors and eighty-six semitrailers. Prior to the field test, one of the participating companies used C-dollies. UMTRI retrofitted the trailers of the other fleets with the necessary hitches and provided the required C-dollies. Twenty-eight C-dollies and sixteen of the fleets’ own A-dollies were used in the study.

The field-study project lasted approximately two years including the effort to retrofit ABS and C-dolly hitches and to create and install instrumentation for 131 units. Because of the interest in reliability and maintenance issues, retrofitting was accomplished as quickly as possible and fleet operations were initiated before instrumentation was available. Fleet operations spanned approximately eighteen months, but the fleet was fully instrumented for only the final eight months.

Miles accumulated during the field study are reviewed in [figures 2 and 3](#). A total of 10.5 million unit-miles were accumulated. Of these, 6.1 million miles were accumulated in field-study trips (i.e., trips in which the vehicle included only units designated for the field study) and 4.4 million miles were accumulated outside of the study. Outside miles were accumulated mostly by tractors; the business realities of the participating fleets required that their expensive power units be utilized to a greater extent than would have been possible had they been restricted to only field-study operations.

The test fleet covered 1.4 million miles on field-study trips. (By definition, there is a virtual one-to-one comparison between field-study-trip miles and the miles accumulated by tractors on field-study trips.) Approximately half (52 percent) of these miles were accumulated by Rocky Mountain doubles, 29 percent by triples, and 19 percent by western doubles.

Complete electronic data records were obtained for about 45 percent of the trips for which instrumentation was available, or a total of about 350,000 miles ². The analyses of lateral-acceleration performance that follow are based on these 350,000 trip miles.

To obtain data for comparing physical performance, it was necessary to operate the instrumented fleet with both A-dollies and C-dollies. Considering this problem only, a fifty-fifty split in mileage would have been most desirable. However, given (1) the limited time period of the study, (2) a strong interest in operational data, and (3) a presumption that the contrast between A-train and C-train behavior would be readily apparent, miles accumulated with C-dollies were maximized. Thus, only 16 percent of the 350,000 instrumented trip-miles were gathered using A-dollies.

Each tractor and each trailer were equipped with a frame-fixed lateral accelerometer (plus other instruments for the ABS portion of the study) and data-logging equipment.³ The data signals from these accelerometers were monitored continuously while the vehicles were in use. To make data storage manageable, these signals were processed on line in the vehicle and were stored in reduced forms. Fleet personnel downloaded data following each trip and

these data were telecommunicated to computers in the offices of the researchers.

The results presented below derive from cumulations of data over many trips. That is, results are not presented for *one* vehicle or *one* trip, but rather for the average of all the data of all the trips of all the vehicles of a specific class.⁴ Data classes may be defined by vehicle configuration, dolly type, loading, speed, etc. In this paper, results in the frequency domain (rearward amplification) derive only from driving situations characterized by no braking and low to moderate lateral acceleration. Results in the time domain (lateral-acceleration histograms) derive only from nonbraking driving situations. Details of data logging and processing appear in the appendix.

ANALYSES IN THE FREQUENCY DOMAIN—REARWARD AMPLIFICATION

Figure 4 provides one example of the rearward amplification behavior observed in the field-study fleet. These results are for loaded triples traveling in the range of 55 to 65 mph. The graph on the left is for triples operated as A-trains, and the graph on the right is for these vehicles as C-trains.

The graphs of figure 4 show rearward amplification as a function of frequency for each of the three trailers, respectively, and over the frequency range of interest. Measurement of rearward amplification during the *normal* travel of this study, yet covering this full frequency range, was possible because the small disturbances input to the tractor from road roughness and other external sources apparently provide adequate input power in the higher frequency range. The fact that rearward amplification is readily apparent even in vehicle motions generated in this way is simply confirmation that this property is quite powerful and is always present in these vehicles; it is not a property unique to emergency situations.

Nevertheless, figure 4 does display rearward-amplification properties that are remarkably similar to those obtained in traditional analyses and test track experiments that do simulate emergency maneuvers [5,6,7]. That is: (1) rearward amplification is a strong function of frequency, peaking in the range of 0.33–0.5 hz for these short-trailer vehicles; (2) rearward amplification grows with each successive trailer regardless of dolly type in use; (3) peak amplification of the second trailer of the loaded, short-trailer A-train is in the range of 2 to 2.5 and nearly twice that (4.8 in this case) for the third trailer; (4) C-dollies substantially reduce rearward amplification—the rearward amplification of the *third* trailer of the C-trains is roughly equivalent (but somewhat lower in this case) to that of the *second* trailer of the A-trains.⁵

Summary results for other configurations of vehicles appear in figures 5 and 6. Rather than presenting the full rearward amplification plots (as in figure 4), these two figures show only the *peak* values of amplification taken from those plots. Peak rearward amplification (on the vertical axis of figures 5 and 6) is then shown as a function of speed (on the horizontal axis) with the presentations distinguishing between vehicle configuration, dolly type, and loading condition.

Figure 5 gives the summary data presentation for western doubles and triples. The two graphs at the top of the page are for empty vehicles and the two lower graphs are for loaded vehicles. Graphs on the left are for A-trains and graphs on the right are for C-trains.

The results for the two types of vehicles that use short trailers exclusively (western doubles and triples) are superimposed in this figure because previous work suggests that, for A-trains, the first and second trailers should behave similarly regardless of the presence or absence of the third [8,9]. The data of the figure tend to support this with qualified success. Certainly the tendency for rearward amplification to increase with each successive trailer is shown to hold uniformly across all conditions represented in the figure. The contrast between the left and right graphs clearly shows the advantage of the C-dolly over the A-dolly in all the applications of short-trailer combinations examined. The data of figure 5,

particularly the A-train data, also reflect the tendency for rearward amplification to increase with increasing vehicle speed. This is another property in which the field-study data clearly agree with previous findings [5,6,8,9]. (This trend, of course, is the reason that results for travel below 35 mph are not presented.)

Finally, in contrast, the comparison between the results for empty and loaded vehicles in figure 5 does not show the trends that would be expected based on previous work. In general, earlier findings suggest that rearward amplification should be somewhat more severe in loaded vehicles than in empty vehicles [6,8,9]. It would appear that the opposite is generally true in these data. We suspect this difference in results derives from the fact that traditional work concentrated on measurements made during moderate to severe maneuvers, while the vast majority of data leading to these results comes from the very minor “maneuvering” taking place hour after hour in ordinary, down-the-road travel. In this regime, there are many relatively minor mechanisms that may be more important than they are in severe maneuvers. For example, the relative importance of small amounts of play in the pintle hitches is surely more significant in minor maneuvering than in severe maneuvering.

Figure 6 presents results for Rocky Mountain doubles and reverse Rocky Mountain doubles in the same format used in figure 5. (There is no particular conceptual reason to superimpose the results for these two vehicles as there was for short-trailer doubles and triples. They are placed on the same graph simply to enhance comparison.) When using A-dollies, the trailers of these two vehicles tend to show amplifications similar to those of the first and second trailers of the short-trailer vehicles. This observation conflicts somewhat with previous work that indicates that longer trailer wheelbases result in reduced rearward amplifications [5,6,8,9]. This may be explained by the fact that the shorter trailer of a substantial number of the Rockies in this study was unusually short (24 feet) and used a *tandem-axle* suspension resulting in a trailer with an extremely short wheelbase. The scheme for normalizing PSD data might also be involved. ([See the appendix.](#)) Also of interest, the second trailer of the reverse Rocky displays markedly less rearward amplification than the second trailer of the standard Rocky, while the motions of the first trailer of the reverse vehicle are typically more amplified than those of the standard vehicle. Finally, while the C-dolly tends to improve the performance of these vehicles, the improvement is certainly not so striking as it is for the short-trailer vehicles.

Considering the immense differences between the methodology used in the LCV field study and the methodologies used in previous analytical and experimental investigations, the general agreement between the results shown in figures 4, 5 and 6 and results reported in the literature is striking.⁶ Broadly speaking, these new results would seem to lend further credence to existing findings, and vice versa.

ANALYSES IN THE TIME DOMAIN— LATERAL-ACCELERATION EXPERIENCE

Time-domain analyses of the lateral-acceleration data collected in the field study introduce new information regarding the lateral acceleration of these vehicles as well as corroborating the qualitative observations made in the frequency domain regarding rearward amplification. They also suggest that drivers observe and respond to the lateral stability qualities of their vehicles.

Lateral-acceleration histograms

Figure 7 presents cumulative histograms of the lateral-acceleration experience of all the vehicles of the LCV field study in travel above 45 mph. The upper graph results from data collected on vehicles equipped with A-dollies and the lower graph is for vehicles using C-dollies. Within each graph, results are shown separately for the tractor and the first, second, and third trailers.

The vertical dimension of these graphs represents the percentage of time traveled in which the vehicle experienced lateral accelerations above the value indicated on the horizontal axis. Of course, the absolute value of lateral acceleration is used in both cases. The vertical scale is logarithmic.⁷

The graphs show that the large majority of travel takes place at very low lateral accelerations. At the tractor, only about 15 percent of travel time occurs above 0.03 g, and less than 1 percent of travel time is spent above 0.12 g.⁸

Influences of rearward amplification observed in the time domain

The influence of rearward amplification is readily apparent in the *relative* experience of the tractors and the trailers that they tow. Examining the upper graph in figure 7, note that, when A-dollies are used, the trailers spend more time at elevated levels of lateral acceleration than do the tractors that pull them. Further, the trend is for each successive trailer to spend more time at higher accelerations than its predecessor. Conversely, the lower graph shows just the opposite trend for vehicles equipped with C-dollies.

Figure 8 presents these same data expressed in a rearward-amplification-like numeric. In this figure, the vertical axes represents the lateral-acceleration experience of the trailers relative to the experience of the tractors. This *relative-experience* numeric is simply the percent-of-time figure for the trailers divided by the associated percent-of-time figure for the tractors.⁹ The plot makes the trends clear: the use of A-dollies exaggerates the lateral-acceleration experience of trailers (values greater than one) while the use of C-dollies attenuates their lateral-acceleration experience (values less than one). Both trends generally appear stronger in the more rearward trailers and at more elevated levels of lateral acceleration.

Figure 8 presents data for *all* the vehicles of the field-study fleet—Rockies, doubles, triples; loaded or empty. **Figure 9** focuses on loaded triples only. The trends seen for the entire fleet (figure 8) are largely repeated here, but generally in more orderly forms.⁹ The influence of the C-dolly is very apparent. For example, the third trailers of loaded A-trains experience lateral accelerations above 0.22 g approximately 7.5 times more than their tractors experience that level of lateral acceleration. But, third trailers of C-train triples experienced those same high levels of lateral acceleration only 0.1 times as often as their tractors.

The presentations of figures 8 and 9 (and tabular data for the other configurations of vehicles in the field study that appear in appendix L of [1]) clearly corroborate the findings regarding measurement of rearward amplification in the frequency domain.

Observations that may reflect on the behavior of drivers

While it was not the intention of this study to examine driver behavior, there are qualities in the lateral-acceleration histograms of the tractors that are noteworthy in this regard. These data tend to suggest that drivers take note of the lateral performance qualities of their vehicles and modify their driving behavior to compensate for perceived shortcomings. We caution at the outset of this discussion, however, that the reader should look upon the following as some intriguing observations from the data, but that, in the absence of further study, they certainly do not merit the status of *findings*. This discussion is essentially speculative, and, in the language of the statistician, there is a great deal of potential for the influence of *lurking variables*, not accounted for here. Nonetheless, the data are potentially interesting.

Figure 10 shows the lateral-acceleration histograms for all the tractors in the study. The graph distinguishes between tractors towing A-trains and those towing C-trains. The tractors of A-trains spent considerably less time at elevated lateral accelerations than did the tractors of C-trains. This may suggest that drivers are aware of the oscillatory behavior of the trailing units of A-trains and attempt to compensate for this behavior by driving more precisely.

In pursuit of this line of thought, **figure 11** compares the lateral-acceleration experience of the tractors of loaded LCVs distinguished by (1) vehicle configuration, (2) A- and C-trains, and (3) the experience of the drivers vis-a-vis A- and C-train operations.¹⁰ With one exception (a reversal of the implied ranking of the 3Cx and 2Cx data), the data indicate the following patterns:

- The tractors of Rockies experience more time at higher accelerations than do the tractors of western doubles than do the tractors of triples.
- The tractors of C-trains experience more time at higher lateral accelerations than do the tractors of A-trains.
- The tractors of C-trains with drivers experienced (more confident?) with C-dollies experience more time at higher lateral accelerations than do the tractors of C-trains with novice drivers.

Although we note again, that the experiment was not formed to address this subject and there is substantial potential for confounding influence by other factors, all three of these trends are of the polarity that might be expected if the experience of higher levels of lateral accelerations were being influenced by the confidences and/or cautions of the driver in response to the perceived lateral stability of his vehicle.





REFERENCES

1. Winkler, C. B.; Bogard, S. E.; Bowen, M. A.; Ganduri, S. M.; Lindquist, D. J. An operational field test of long combination vehicles using ABS and C-dollies. Final report. Michigan University, Ann Arbor, Transportation Research Institute. 1995. 2 volumes. 168/262 p. UMTRI-95-45-1/2. DOT HS 808 352/3.
2. Bogard, S. E. and Winkler, C. B. "Maintenance, reliability, and operating costs of C-dollies in LCV operations." *Proceedings*. Fifth International Symposium on Heavy Vehicles Weights and Dimensions. ARRB Transport Research Ltd. 1998.
3. Winkler, C. B. and Bogard, S. E. "The performance of antilock braking systems on long combination vehicles." *Proceedings*. International Large Truck Safety Symposium, University of Tennessee Transportation Center, Knoxville, Tennessee, October 27–29, 1997, pp 407-422.
4. Bogard, S. E. and Winkler, C. B. "Maintenance, reliability, and operating costs of antilock braking systems in LCV operations." *Proceedings*. International Large Truck Safety Symposium, University of Tennessee Transportation Center, Knoxville, Tennessee, October 27–29, 1997, pp 423-442.
5. Ervin, R.D.; Fancher, P.S.; Gillespie, T.D.; Winkler, C.B.; Wolfe, A. Ad hoc study of certain safety-related aspects of double-bottom tankers. Final report. Highway Safety Research Institute, Ann Arbor, Mich. 1978. 78 p. UM-HSRI-78-18-1.
6. Winkler, C. B.; Fancher, P. S.; Carsten, O.; Mathew, A.; Dill, P. Improving the dynamic performance of multitrailer vehicles: a study of innovative dollies. Final report. Michigan University, Ann Arbor, Transportation Research Institute. 1986. 2 volumes. 246/58 p. UMTRI-86-26-I/II. FHWA/RD-86-161/162.
7. Aurell, J. and Winkler C.B. "Standard test procedures for the lateral stability of heavy vehicle combinations." *Road transport technology—4. Proceedings*. Edited by C.B. Winkler. Fourth International Symposium on Heavy Vehicles Weights and Dimensions. University of Michigan Transportation Research Institute. Ann Arbor. pp 463–471. 1995.
8. Mallikarjunarao, C. and Fancher, P. S. Analysis of the directional response characteristics of double tankers. Highway Safety Research Institute, Ann Arbor, Mich. 1978. 20 p. SAE 781064.
9. Fancher, P.S. The transient directional response of full trailers. University of Michigan Transportation Research Institute, Ann Arbor. 1982. 22 p. SAE 821259.



APPENDIX

Standard vehicle instrumentation and data loggers

Since the field test took place in the context of real commercial service, the most important requirements of the instrumentation system were that (1) it place a minimal time and logistical burden on the trucking operation, and (2) it be reliable in extended, real operation. Among other things, this meant no inter-unit wiring. Hence, each instrumented vehicle unit in the field study—tractor, trailer or C-dolly—carried its own, independent instrumentation system. The systems measured and recorded activity on their own units and did not communicate with other units of the vehicle except to draw power from the auxiliary circuit of the standard, seven-element wire that runs the length of the LCV.

The instrumentation systems were equipped to monitor a number of variables, most of which were associated with braking and the performance of ABS systems. The system for each tractor and trailer was also equipped with a frame-fixed lateral accelerometer.

The systems operated in two basic modes. (1) For the majority of the time, vehicle activity was monitored and recorded in reduced form. During these periods, lateral acceleration was logged in the form of magnitude histograms and PSDs. (2) When the monitoring function indicated an unusual event, continuous time histories were recorded. The recording of time histories was triggered based on the occurrence of (1) moderate to severe braking, (2) substantial ABS or wheel-lock events, (3) lateral acceleration in excess of 0.2 g for 0.3 seconds.

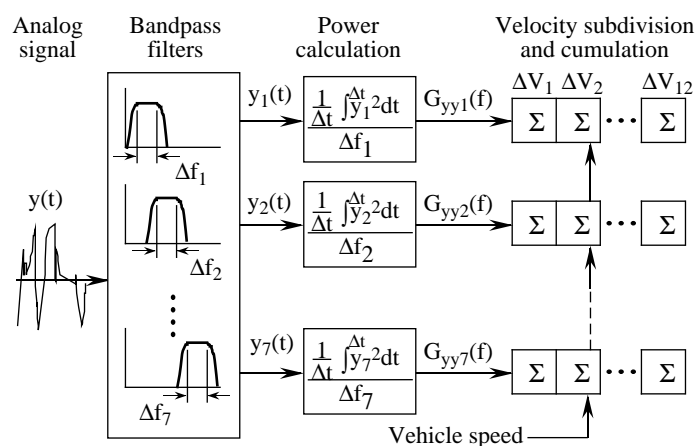

Fig. A-1. Schematic diagram of lateral-acceleration PSD data-logging system

Lateral-acceleration histograms and PSDs were logged separately for times at which brake lights were on and brake lights were off. Only data related to the brake-lights-off condition are reported herein. PSD logging was discontinued during time history recording. Thus, in this paper, the histogram data derive only from nonbraking driving conditions and the PSDs deal only with driving conditions characterized by no braking and low to moderate levels of lateral accelerations.

Lateral-acceleration histograms and PSDs were also segregated by vehicle speed according to the following speed ranges: 5–15, 15–25, 25–35, 35–45, 45–55, 55–65, >65. Data was not collected below 5 mph. Thus, the data-logging matrices can be thought of as two-dimensional, one dimension for the base measure and one dimension for vehicle speed.

The base measure for the lateral-acceleration histograms was, of course, magnitude (i.e., absolute value) of lateral acceleration. Twelve lateral-acceleration ranges were established as follows: 0.0-0.03, 0.03-0.06, 0.06-0.09, 0.09-0.12, 0.12-0.16, 0.16-0.19,

0.19-0.22, 0.22-0.25, 0.25-0.34, 0.34-0.40, 0.40-0.47, >0.47 g. The logged quantity was cumulative time spent with the vehicle operating within the specified ranges of lateral acceleration and forward speed.

The base measure for the PSDs was frequency and the logged quantity was cumulative signal power within the frequency range with the vehicle operating in the specified range of forward speed. Seven frequency ranges were established as follows: 0.24–0.27, 0.27–0.31, 0.31–0.36, 0.36–0.44, 0.44–0.57, 0.57–0.8, 0.8–1.3 hz. Frequency separation was accomplished by feeding the analog accelerometer signal to a bank of seven bandpass filters. The outputs of the seven filters were then handled as seven individual signals for analog-to-digital transformation. A schematic of the PSD logging system appears in figure A-1.

Special synchronous data loggers

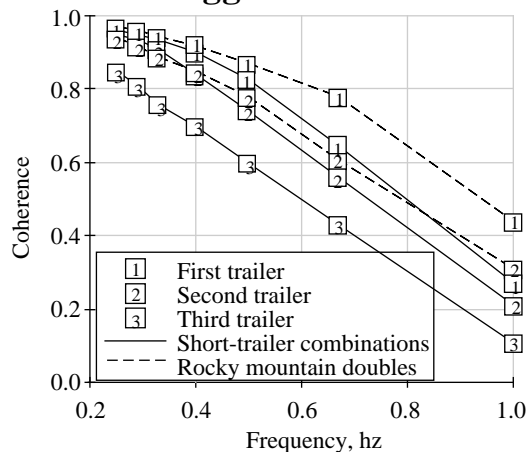

Fig. A-2. Coherence functions used in determining rearward amplifications

One additional, special set of instrumentation and data loggers was used in the field study. This system was capable of continuous, synchronous recording of the lateral-acceleration time histories of the tractor and each of up to three trailers, respectively, along with the forward speed of the vehicle. The purpose of this system was to obtain the data needed to describe the *coherence functions* between the lateral-acceleration response of trailers and the tractors towing them. These coherence functions, along with the PSDs of lateral acceleration gathered by the standard loggers, were used to calculate rearward amplification functions as described in the next section of this appendix.

These units were operated by UMTRI's field representative who rode with the vehicle on the entire trip. A limited number of trips were taken with the system, but at least one trip was made with each configuration and dolly style used by each of the five fleets. A single trip typically involved gathering ten or more hours of data, often over more than one day.

The time histories gathered in this manner were subjected to conventional analysis in the frequency domain to obtain the needed coherence functions. After considerable examination of the data with respect to load condition, speed, etc., the results were condensed to a single coherence function for each trailer of short-trailer combinations (western doubles and triples) and for each trailer of Rockies, as shown in figure A-2.

Procedure for determining rearward amplification

Calculation of rearward amplification was accomplished on a trip-by-trip basis according to the following process.

In the following, the symbols *i*, *j*, and *k* are indices as follows:

- i varies from 0 to 3 and represents the vehicle unit starting with the tractor and proceeding through up to three trailers
- j varies from 1 to 7 and represents the seven frequency ranges of the PSD data collected by the data loggers (see logger specifications)
- k varies from 5 to 7 and represents the three highest of the seven velocity ranges of the data loggers (above 45 mph, see logger specifications)

The first step in processing was to normalize the PSD data from a unit by the power of the lowest frequency. That is:

$$P'(i,j,k) = P(i,j,k) / P(i,1,k) \quad (A-1)$$

where P is the logged power value and P' is the *normalized* power, the logged power values having been obtained by the process shown in figure A-1. Each P(i,j,k) was typically obtained by integrating (cumulating) over a period of hours. As for any long-term integration, absolute accuracy can only be achieved if the base signal is extremely accurate. Accelerometers of sufficient accuracy to allow absolute comparison (of these measures) across units was not economically or practically feasible. However, it is understood from basic vehicle dynamics, that at sufficiently low frequency, the rearward amplification is unity. Then in this case, the gain of the lowest frequency available was assumed to be one, and the problem of absolute accuracy was avoided by normalizing the data of each unit by the value of its own lowest frequency data.

Rearward amplification was then calculated according to:

$$RA(i,j,k) = [P'(i,j,k) / P'(0,j,k)]^{1/2} * COH(i,j) \quad (A-2)$$

where COH is the appropriate value of the coherence function for the applicable vehicle configuration.

The validity of this approach to the measurement of rearward amplification is worth questioning due to the unconventional elements of (1) the separate determination of coherence and (2) the assumption of a rearward amplification of unity for all trailers at the lowest frequency that is implied by the normalization of the PSD data. As evidence of the validity of the approach, we cite (1) the broad agreement in form of the results presented in this paper to the many findings on rearward amplification presented in the literature, and (2) the following specific comparison of results herein with previous work.

Figure A-3 compares the rearward amplification of the second trailer of an A-train western double determined by simulation of a single vehicle, with the rearward amplifications determined for second trailers of the short-trailer A-trains (doubles and triples shown separately) of the LCV field study. The simulation was for a fully loaded vehicle traveling at 62 mph. The field-study results are for loaded vehicles traveling in the 55–65 mph range.

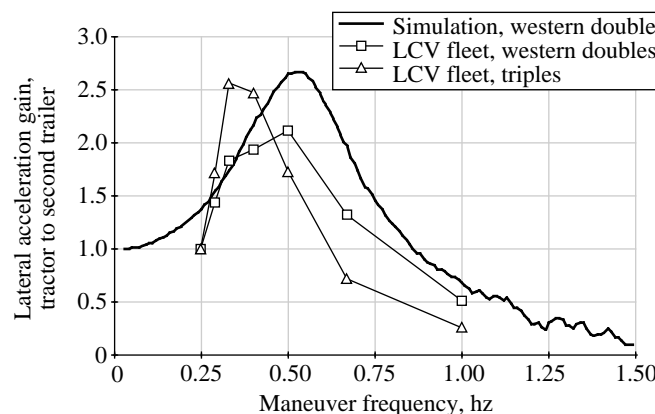

Fig. A-3. Rearward amplification of the second trailer of short-trailer combinations as determined by vehicle simulation and in the field study by assuming a gain of 1.0 at 0.25 hz

The simulation was done on behalf of the International Standards Organization (ISO) in its effort to develop standard test procedures for large trucks [7]. A pseudo-random steering test was simulated. The steering time history used for the simulation was taken from data recorded in actual pseudo-random testing conducted by Volvo Heavy Truck at their test facilities in Sweden. The time histories derived from the simulation were analyzed in the frequency domain by conventional methods and the resulting transfer function gain is displayed in the figure. The results for the field study are derived by the process described above. The comparison is good, particularly for the western double. The shape of the two curves for western doubles is very similar and the two results show peak rearward amplifications occurring at virtually the same frequencies.

Note that in figure A-3, lateral-acceleration gain for the field-study vehicles is identically 1.0 at the lowest frequency of 0.25 hz. This is a direct result of the decision to normalize the PSD data according to the value at this frequency. For the purpose of this discussion on validity, it is of interest to alter the process of normalization to force this value not to 1.0, but to 1.35, under the assumption that this is the correct value at this frequency as indicated by the simulation results. Figure A-4 compares the simulation results with the field-study data that would result from this altered normalization. Under this assumption, the comparison between simulation results and the western double results from the LCV study are even more striking.

Finally on this subject, we note that a data reduction process that normalizes data according to an independently established gain at the lowest frequency (in this case, 1.35 at 0.25 hz) may be more rationally defensible than the process actually used in this work (normalizing to 1 at 0.25 hz). The former method might have been pursued by conducting reference simulations for each of the individual variations of the broad classes of vehicle configuration, loading condition, dolly type, velocity, etc. The rearward amplification value at 0.25 hz found for each trailer in each vehicle in each condition could have then been used as the normalizing reference for that group of units in the LCV study. This method was not pursued for the obvious reason that it would add a great deal of complication without substantially changing the qualities of the findings. We note however, that results from this method would show even greater differences (absolutely and proportionately) between the rearward amplification of vehicles using A-dollies and vehicles using C-dollies than are reported herein. This is so because (1) the reference values would generally be greater than one, and (2) the reference values for normalizing A-dolly data would be larger than the corresponding reference values for normalizing C-dolly data.

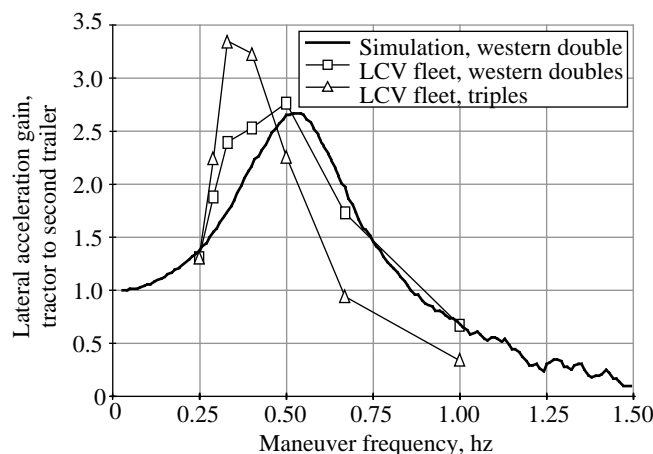

Fig. A-4. Rearward amplification of the second trailer of short-trailer combinations as determined by vehicle simulation and in the field study by assuming a gain of 1.35 at 0.25 hz



FOOTNOTES



- 1 Numbers in brackets refer to bibliographic references given at the end of this paper.



- 2 A successful trip in this regard required that only instrument-equipped units were present in the vehicle, that all elements of the individual instrumentation and data-logging systems on each unit of the vehicle functioned correctly, that the fleet personnel performed trip-logging, data-downloading, and transmission tasks properly for each unit, and that the telecommunication system from fleet office to UMTRI worked properly. Less-than-perfect reliability of each of these elements combined to cause an overall success rate of roughly 45 percent. The authors look upon this with mixed feelings: Forty-five percent success does not seem so good, but even at this rate, the amount of data collected was rather overwhelming.



- 3 Dollies were equipped with data loggers and instrumented for monitoring braking performance. The dollies themselves were not equipped with accelerometers, however. Although examining the influence of dolly design on lateral performance was the goal, the influence of the dollies on the motion of the trailers was the point of interest.



- 4 By *all* trips, we mean all trips from which satisfactory data records were derived.



- 5 An extensive presentation of results similar to those from which figure 4 derives, is presented in appendix L of [1].



- 6 See the appendix for a discussion of the field test methodology and a comparison of a sample of these results with previous work.



- 7 Lateral-acceleration data were collected in discrete bins up to 0.47 g. Generally, however, the data above 0.22 g was so sparse as to produce very “noisy” results in the analyses. Accordingly, the presentations of this section generally show cumulative histogram data up to 0.22 g. (Note that the higher data is not excluded, but is lumped as “above 0.22.”)



- 8 One percent should not be interpreted as an insignificant period of time. Consider the driver who covers 100,000 miles per year averaging 50 mph. That is 2000 hours per year, or the equivalent of a forty-hour work week. At the 1 percent figure, this driver would spend twenty hours per year in this elevated range of lateral acceleration.



- 9 In the development of figure 8, the division of trailer data by tractor data is done *after* the cumulation of data. This is in contrast to the method used to develop rearward-amplification data in which the division in the frequency domain was done on a trip-by-trip basis and the results then cumulated. In retrospect, this latter approach would be more appropriate in both cases, and would probably lessen some of the erratic quality of figure 8. For example, the decline in the relative experience measure of the third trailers of A-trains shown at the higher accelerations of figure 8 is due in part to the fact that third trailer data is divided by all tractor data (including the tractors of doubles). This problem is attenuated when less-inclusive data sets are analyzed, as in figure 9.



- 10 One of the five participating commercial fleets had used C-dollies exclusively for several years prior to this study and did not use A-dollies at all in the study. The drivers of this fleet are considered “experienced” in the use of C-trains, while the drivers of the other four fleets are considered “experienced” with A-trains but “novices” with C-trains. Therefore, with respect to figure 11, the “A-train, experienced” and “C-train, novice” data are for essentially the same drivers traveling the same routes. The “C-train, experienced” data represents different drivers and different routes.



Rocky Mountain double

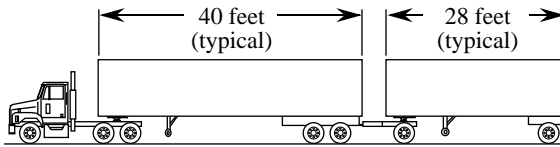

Reverse Rocky Mountain double

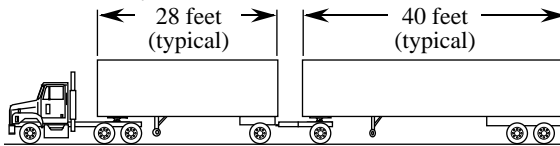

Triple

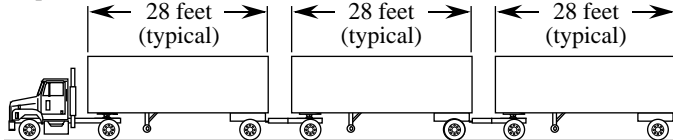

Western double

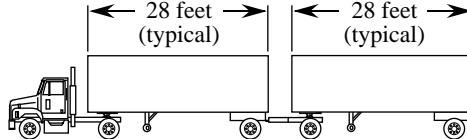

Fig 1. Vehicle configurations in the LCV field study



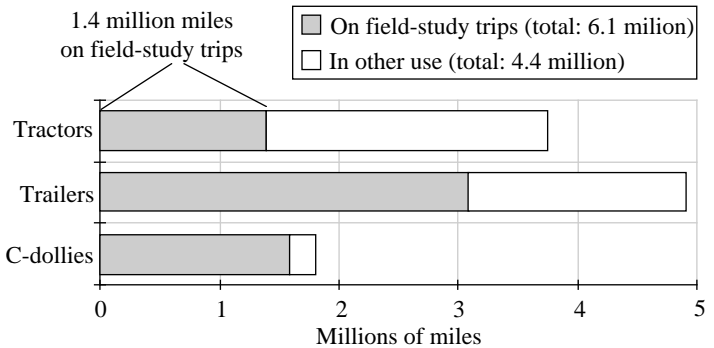

Fig. 2. Unit-miles accumulated during the LCV field study

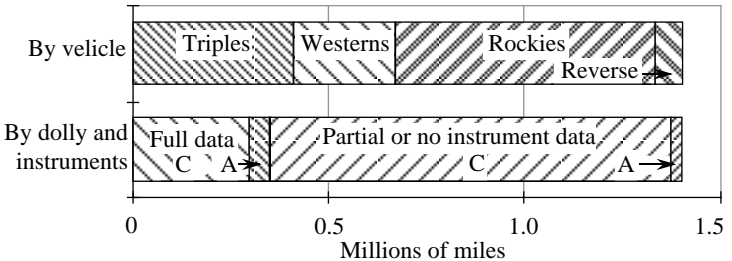

Fig 3. Distributions of trip miles accumulated during the LCV study



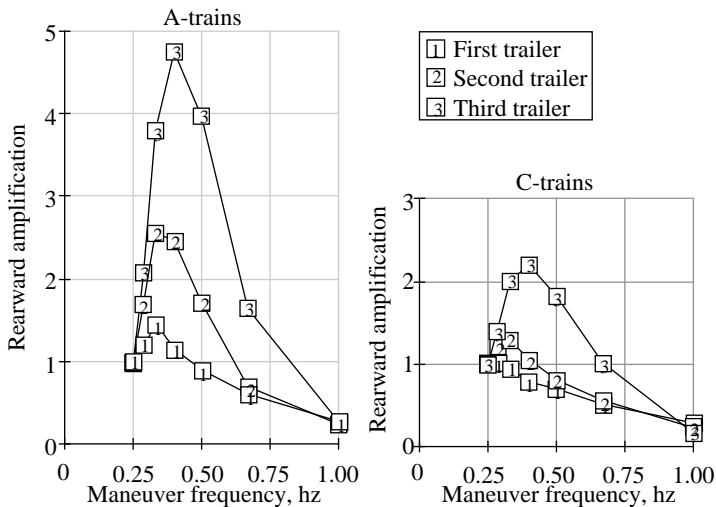

Fig. 4. Rearward amplification of loaded triples, 55-65 mph



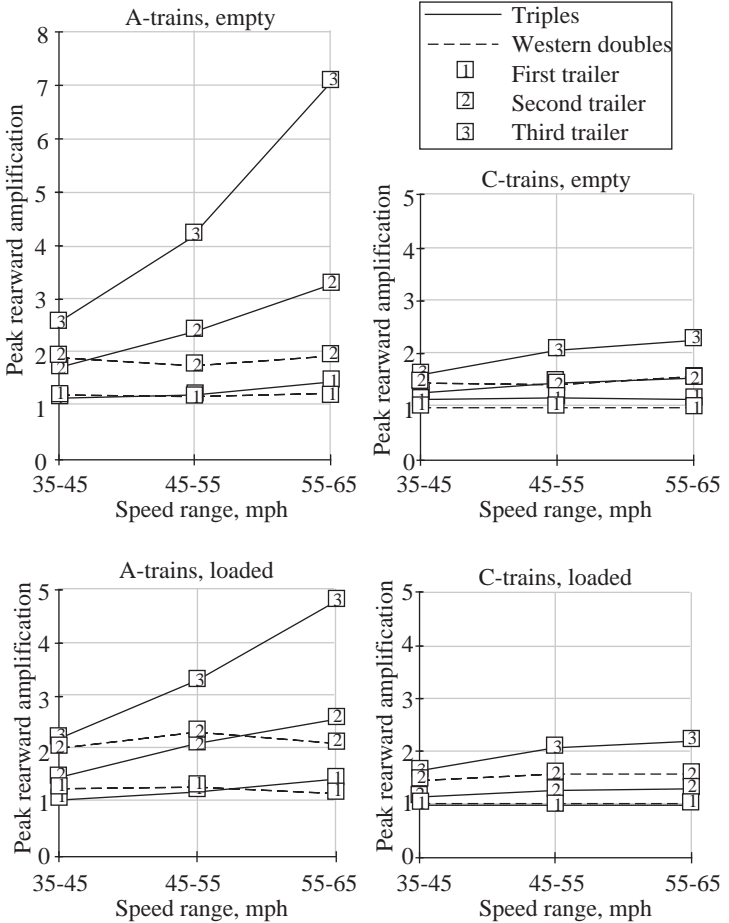

Fig. 5. Peak rearward amplifications of short-trailer combinations

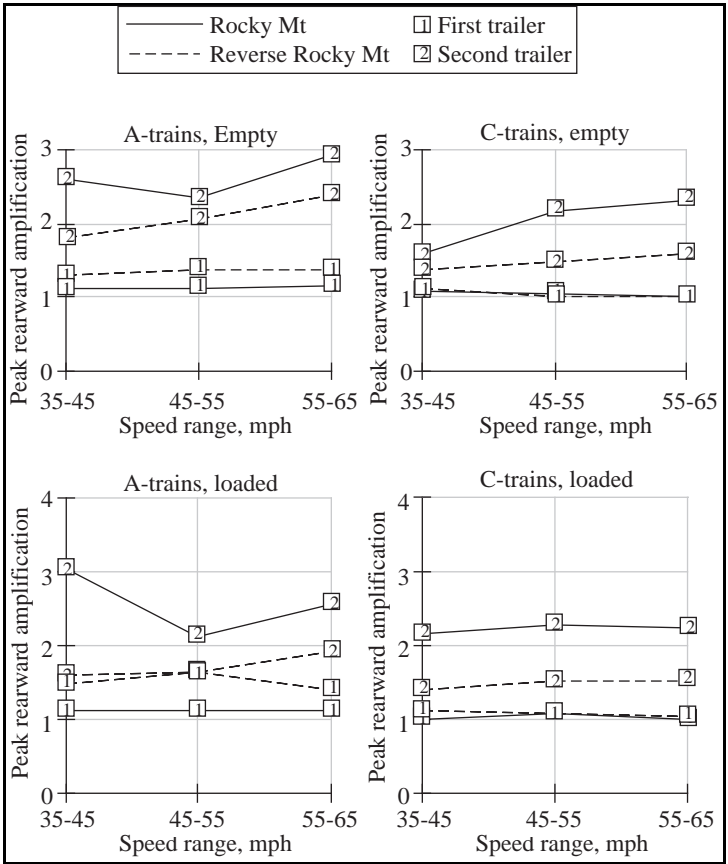

Fig. 6. Peak rearward amplifications of Rocky Mountain doubles



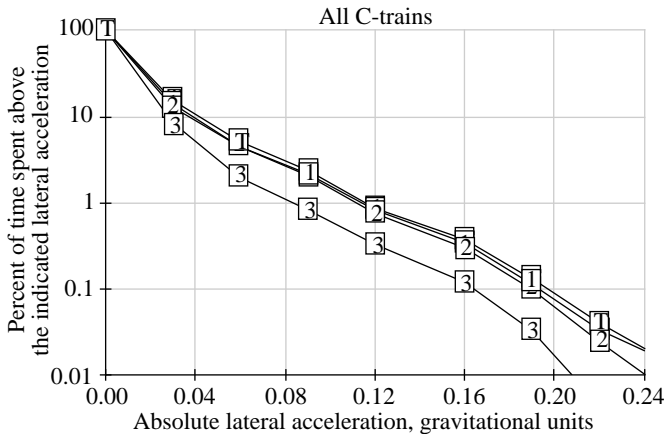
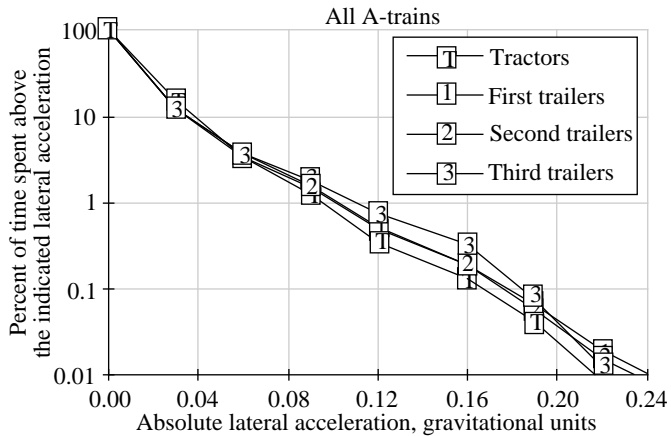

Fig. 7. The lateral-acceleration experience of all vehicles distinguished by dolly type, above 45 mph



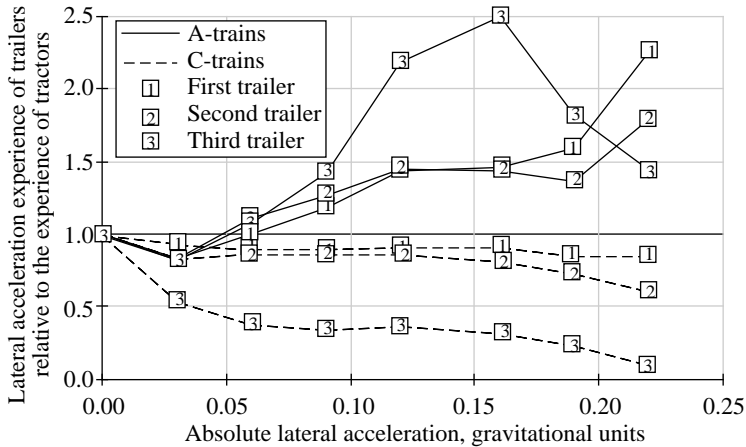

Fig. 8. The lateral-acceleration experience of all trailers relative to the lateral-acceleration experience of all tractors, above 45 mph



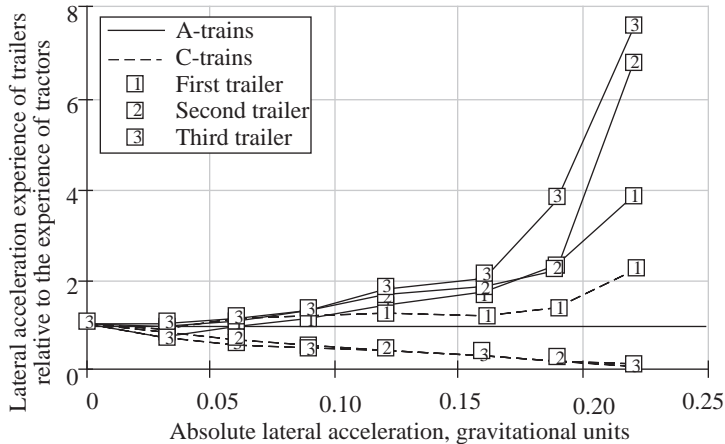

Fig. 9. The lateral-acceleration experience of trailers of triples relative to the lateral-acceleration experience of tractors of triples, above 45 mph



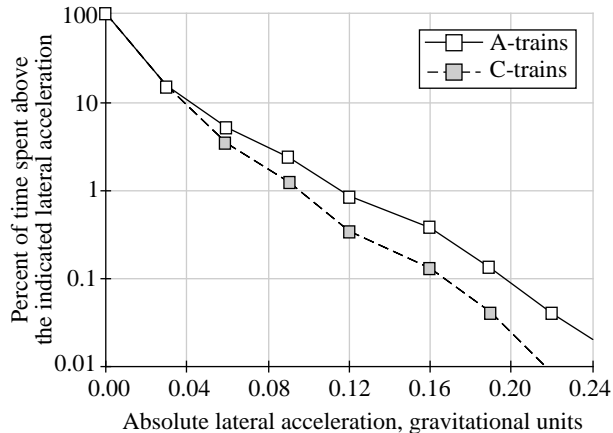

Fig. 10. Comparison of the lateral-acceleration experience of the tractors of A-trains and C-trains, respectively, above 45 mph



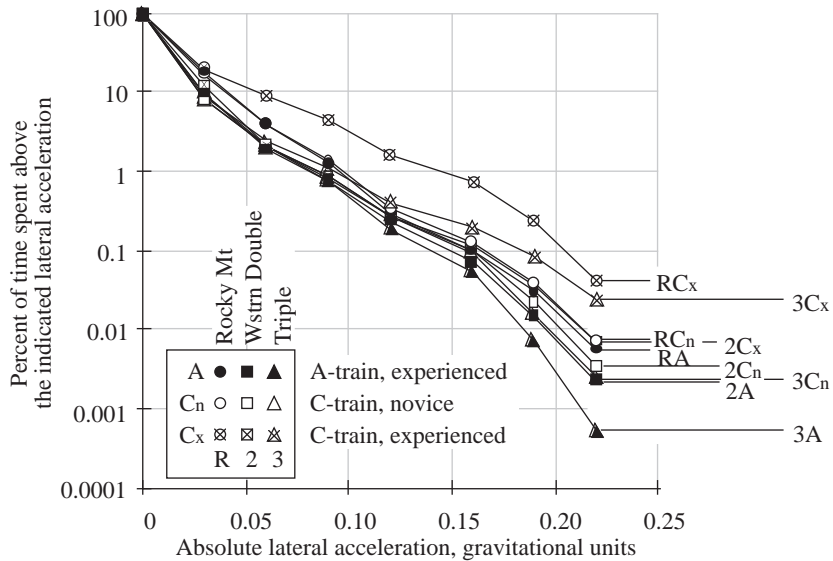

Fig. 11. The lateral-acceleration experience of the tractors of loaded LCVs, above 45 mph

